

Zoom Lens

This zoom lens is designed for use with Panasonic's applicable projectors. The lens makes it possible to vary the projection distance by changing the focal distance.

NOTE: Please use the lens only on the specified Panasonic projector.

Specifications

F value:	2.5
Focal distance (f):	96.6–154.1 mm
Throw ratio:	4.6–7.4:1 for PT-DZ21K/DZ8700/DZ110X (16:10 aspect ratio), 5.0–8.0:1 for PT-DS20K/DS8500/DS100X (4:3 aspect ratio), 5.1–8.2:1 for PT-DW17K/DW8300/DW90X (16:9 aspect ratio)
Dimensions (W × H × D):	130 × 130 × 268 mm (5-1/8 × 5-1/8 × 10-9/16 inches)
Weight:	Approximately 5.0 kg* (11.0 lbs*)
Applicable projector:	PT-DZ21K/DS20K/DW17K/DZ8700/DS8500/DW8300/DZ110X/DS100X/DW90X

* Average value. May differ depending on the actual unit.

The throw ratio is an approximate value calculated by dividing the screen width by the projection distance.

Dimensions

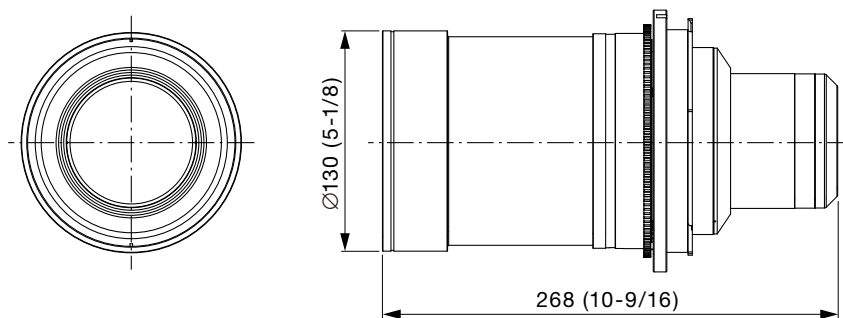

The illustration shows the lens attached to the PT-DZ21K/DS21K/DW17K.

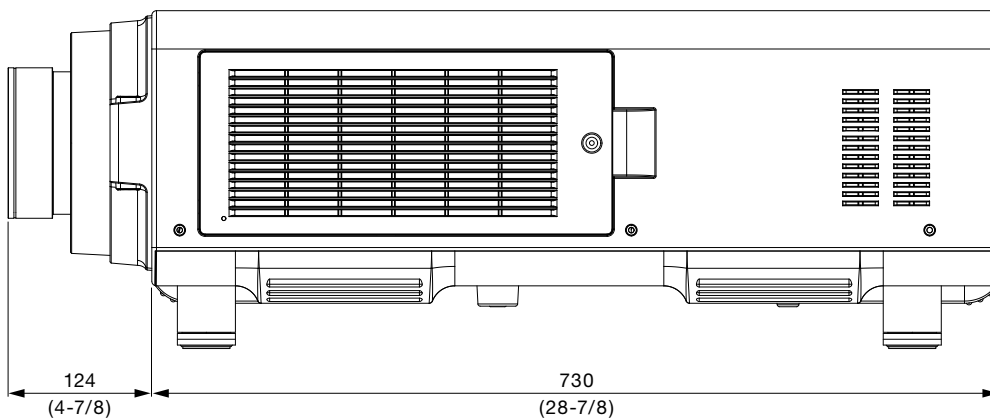

The illustration shows the lens attached to the PT-DZ8700/DS8500/DW8300/DZ110X/DS100X/DW90X.

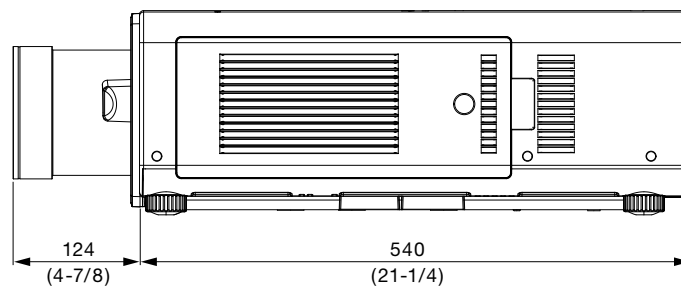

unit : mm (inch)

NOTE: This illustration is not drawn to scale.

NOTE: Please read the projector's instruction manual for throw distances.
Weights and dimensions shown are approximate. Specifications subject to change without notice.