











Visidec Freestanding | Dual horizontal VFS-DH

-  Suits 75x75 & 100x100mm (opt. 200x100mm support)*
-  Freestanding desk mount
-  Suits displays up to 12kgs (26.5lbs)
-  Holds two displays
-  Tool-less tilt & pan adjustment
-  Quick Release mounting head
-  Allows positional adjustment
-  Adjustable screen orientation

The Visidec Freestanding Dual Horizontal is a compact and durable desk stand that holds two monitors with position and height adjustability. The minimal footprint and integrated cable management ensure a flexible and clutter-free work environment. Detachable display mounting heads support a wide variety of VESA compatible monitors with Quick Release for easy installation / maintenance and Quick Shift for easy adjustment. The heads feature a ball joint that allows tilt/ pan adjustment and landscape to portrait screen rotation. Integrated tension control ensures touch-screen support and the product ships with security screws to deter unauthorized screen removal.

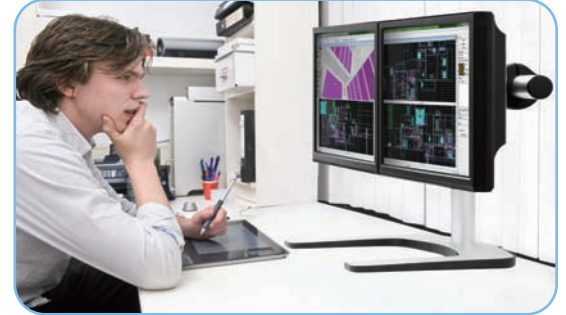

Product key features:

- ✕ Holds two displays, each up to 635mm (35") wide and 12kgs (26.5lbs) in weight
- ✕ Made from strong die cast aluminum with a steel base
- ✕ Ball joint mechanism allows +/-20° of tilt and pan adjustment as well as 360° screen rotation
- ✕ Integrated tension control for touch-screen compatibility
- ✕ Provides up to 449mm (17.68") of height adjustment
- ✕ Provides up to 635mm (25") of horizontal adjustment with easy Quick Shift operation.
- ✕ Quick Release mounting heads enable easy display installation and maintenance with security screws to deter unauthorized removal.
- ✕ Small 422mm (16.25") wide by 305mm (12") deep footprint
- ✕ Provides a choice of internal and external cable management
- ✕ Comes with display mounting hardware



Height adjustable

Small foot print

Strong die cast aluminium construction with sturdy steel base

Quick Release mechanism for easy display attachment/removal with a security feature.

Quick Shift donut mechanism for easy horizontal adjustment

Ball joint mechanism allows display adjustment up to 20° in any direction

Internal & external cable management

* Also supports 200x100mm via optional adaptor plate



Atdec Global www.atdec.com.au
Atdec North America www.atdec.com

Product information, single unit

Product Code	Load capacity	Material	Color
VFS-DH	12kg (26.5lbs) per display	Extruded anodized aluminium construction with a steel base and plastic trim.	Silver

Package information, single unit

Size	Ship weight	UPC code	Contents
53cm x 34cm x 11cm (20.25" x 13.5" x 4.25")	5.8kg (13.2lbs)	881493005129	Stand, mounting heads (x2), security screws (x2) & display mounting hardware

Package information, master pack

Size	Ship weight	UPC	Units per master pack
53cm x 36cm x 34cm (21" x 14" x 14")	20kg (40.6lbs)	881493005174	3

Technical drawings

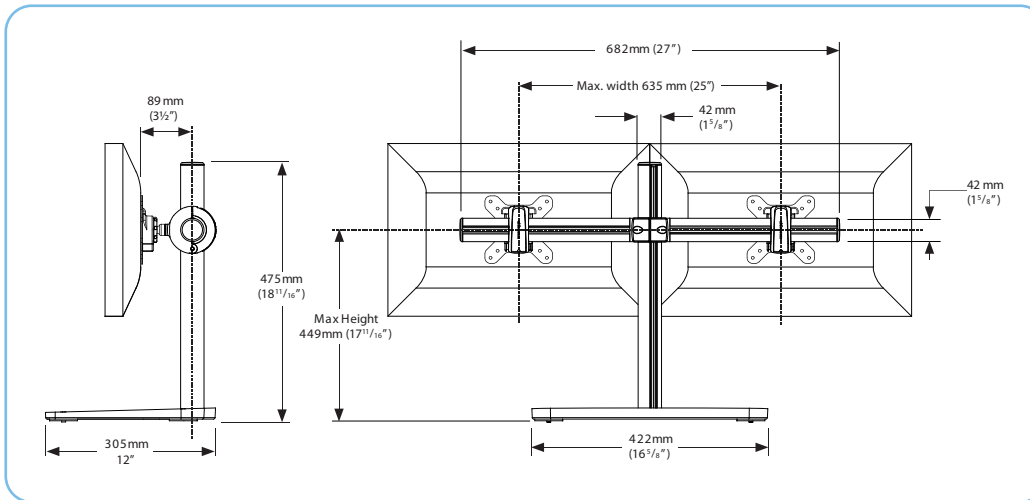

Base Dimensions

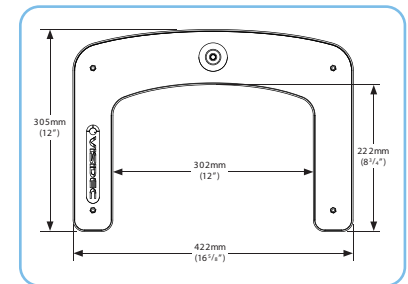

Optional Accessories

AC-AP-2010	200x100 Adaptor Plate
------------	-----------------------

Other models in this range

VFS-DV	Freestanding Dual Vertical
VFS-Q	Freestanding 2 X 2 Quad

Included VESA attachment

